



06

# EQUIPAMIENTO DE ATLETISMO

## ATHLETICS EQUIPMENT

- A Carreras Races
- B Lanzamiento Throwing
- C Salto con pértiga Pole vault
- D Salto de altura High jump
- E Salto de longitud y triple salto Long jump and triple jump
- F Útiles de medición Measuring equipment
- G Varios Accessories



**GALVAN**  
SPORT



**A**CARRERAS / Tacos de salida **RUNNING / Starting blocks****33360**

Taco de salida de competición Elite Wide con pedales de caucho y cara de aluminio certificado IAAF Con carril en perfil de aluminio de 80 mm.

A top class Elite Wide starting block with wider rubber faced and pedals made of aluminium. 80 mm. aluminium rail. IAAF certified.

*Imagen/Picture A*

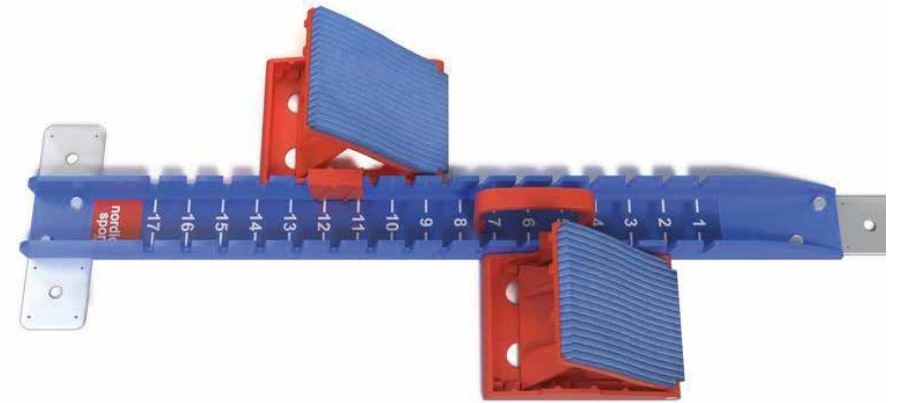
**A****33359**

Taco de salida de competición certificado IAAF Pedales de aluminio con revestimiento en goma. Ajustable en 5 posiciones con carril de 80 mm. en perfil de aluminio.

A top class starting block with rubber faced pedals made of aluminium. Adjustable in 5 positions. 80 mm. aluminium rail. IAAF certified.

*Imagen/Picture B*

**B****33359A**

Taco de salida Nordic Olympic con pedales y carril de 65 mm.

Nordic Olympic starting block with narrower pedals and 65 mm. rail.

*Imagen/Picture C*

**C**



33022

Carro portatacos de salida.  
Starting block carrier rack.

*Imagen/Picture D*



D

33011B

Valla atletismo competición en aluminio. Certificada IAAF.  
Aluminium competition hurdle. IAAF certified.

*Imagen/Picture E*



E

33010

Valla escolar metálica lacada,  
5 alturas oficiales.  
Powder coated metallic hurdle  
for schools, 5 official heights.

*Imagen/Picture F*



F

33011

Valla atletismo reglamentaria de  
5 alturas oficiales de competición,  
incluye contrapesos interiores.  
5-heights competition hurdle with  
inner metallic counterweights.

*Imagen/Picture G*



G

**A**CARRERAS / Vallas de atletismo **RUNNING / Hurdles****33010A**

Valla escolar de 10 alturas y doble posición. Regulación por simple presión.

10-heights, two-position hurdle for schools. Simply press to adjust.

*Imagen/Picture A*

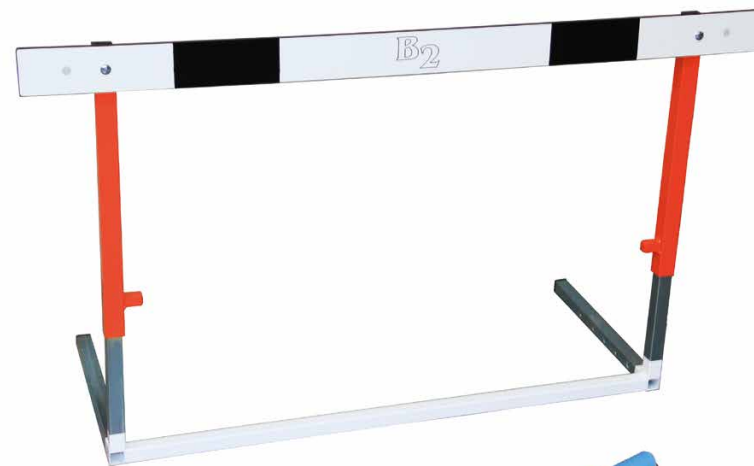
**A****33010B**

Valla atletismo antilesión, 3 posiciones 25 - 30 - 40 cm.

Anti injured hurdle, 3 positions 25 - 30 - 40 cm.

*Imagen/Picture B*

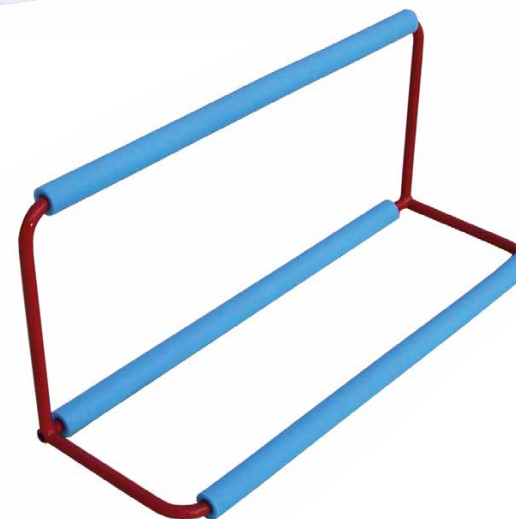
**B****33358**

Obstaculín para entrenamiento, altura 30 cm.

Low training hurdle, height 30 cm.

*Imagen/Picture C*

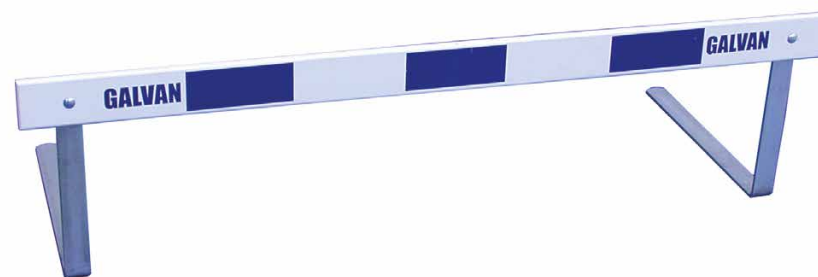
**C**



33007

Obstáculo de 3,96 m, regulable en altura de 0,762 a 0,914 m.  
3,96 m. steeplechase hurdle. Adjustable height: 0,762 to 0,914 m.

*Imagen/Picture D*

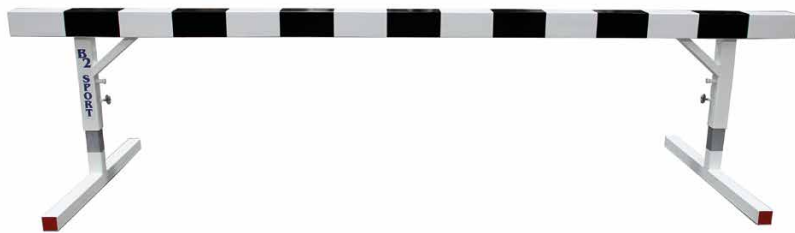

D



E

Obstáculo de ría de 3,66 m. fabricado en madera, con postes metálicos.  
3,66 m. water jump hurdle. Made of wood with metallic posts.

*Imagen/Picture E*

33019A

F



Carro porta vallas, cuatro ruedas neumáticas con carga trasera.  
Capacidad 25 Uds.

Metallic hurdle cart with four pneumatic wheels. Back loaded.  
Capacity: 25 hurdles.

*Imagen/Picture F*

33576A

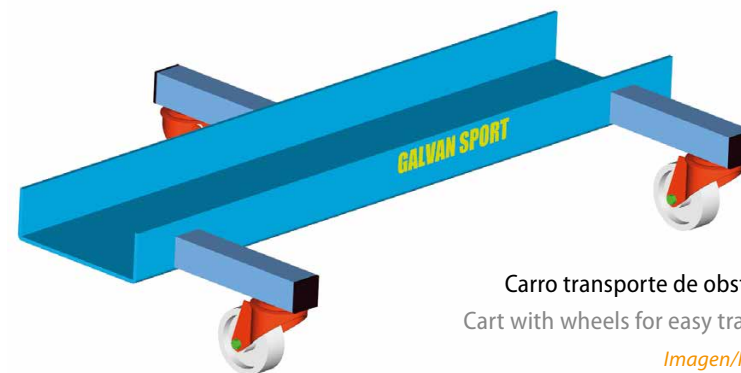

Carro transporte de obstáculos.  
Cart with wheels for easy transport.

*Imagen/Picture G*

33007A

G

**A****33016****Juego de postes de llegada anclados.**

Finish line posts with fastening.

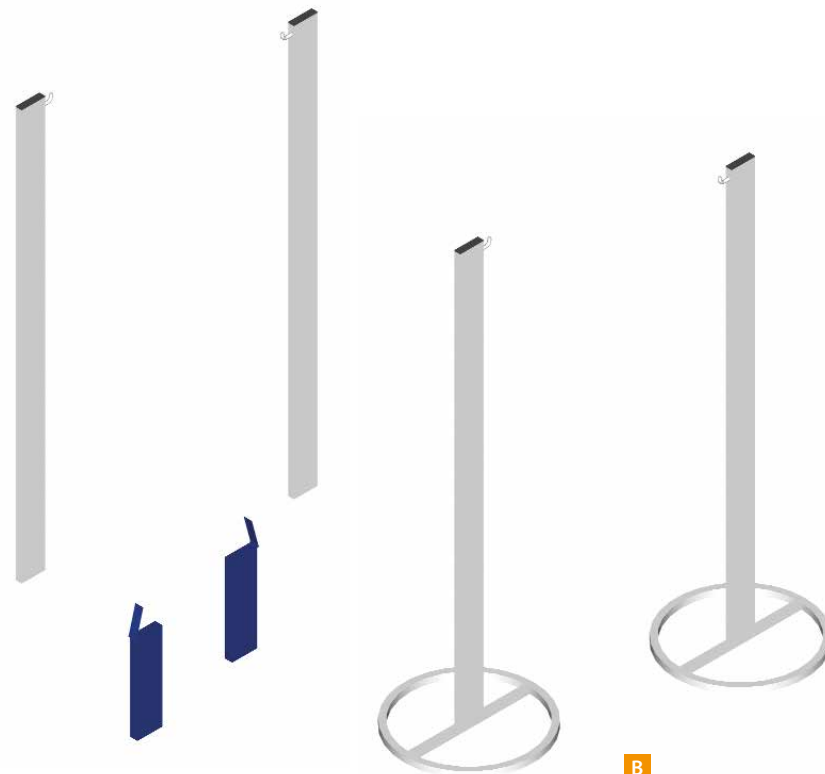
*Imagen/Picture A***A****33017****Juego de postes de llegada con base.**

Finish line posts with base weighted.

*Imagen/Picture B***B****33572****Bordillo de aluminio para pistas de atletismo con grapas de fijación a pista.**

Aluminium kerb for running track with track fixing clips.

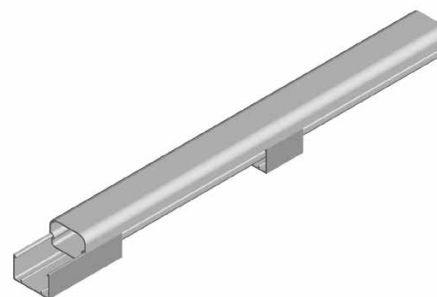
*Imagen/Picture C-D***C**



33573

Placa de señalización en aluminio con inscripciones autoadhesivas.  
Aluminium signaling plates with self-adhesive inscriptions.

*Imagen/Picture D*



D

33005A

Prisma indicador de salidas de alta competición con tres caras, fabricado en fibra de vidrio. Puede ser equipado con indicador de salidas falsas.

Top competition three faces lane marker made of fibreglass. It can be equipped with false output indicator.

*Imagen/Picture E*



E

33003

Podium juez de salidas metálico con pasamanos frontal y lateral. Con ruedas para su fácil traslado.  
Metallic start line podium for judges. Includes front and side handrails. With wheels for easy transport.

*Imagen/Picture F*



F

33005

Prisma indicador de calle de alta competición.  
High competition lane marker box.

*Imagen/Picture G*



G



A



33004

Pantalla de juez de salida. Con bastidor metálico y pantalla en color negro. Regulable en altura.

Black screen start line judges with metal frame. Includes height adjustment system.

*Imagen/Picture A*

570910

Testigo de relevo en aluminio anodizado de Ø 38 mm. Certificado IAAF.

Relay baton in anodized aluminium Ø 38 mm. IAAF. Certified.

*Imagen/Picture B*

33023

Cuentavueltas metálico con dos dígitos y campana.

Lap counter with bell.

*Imagen/Picture C*

A



B



C



33023A

Cuentavueltas electrónico.

Electronic lap indicator.

*Imagen/Picture D*

D







33014

Escalera de jueces metálica de 12 asientos.  
12 seats metallic judge stand.

*Imagen/Picture E*

E

33012

Escalera de jueces metálica de 4 asientos.  
4 seats metallic judge stand.

*Imagen/Picture E*

33013

Escalera de jueces metálica de 8 asientos.  
8 seats metallic judge stand.

*Imagen/Picture E*



B

LANZAMIENTOS THROWING



33040A

Jaula de lanzamiento para círculos tangenciales con postes metálicos galvanizados. Certificada IAAF (Red no incluida).

Tangential circles hammer and discus cage. Stable base made from galvanized steel profiles. IAAF certified (Net not included).

*Imagen/Picture A*

33040

Jaula de lanzamiento para círculos tangenciales con postes metálicos galvanizados. Fabricada conforme a normas IAAF (Red no incluida).

Tangential circles hammer and discus cage, according to IAAF regulations. Stable base made from galvanized steel profiles (Net not included).

*Imagen/Picture B*

33047

Red sencilla para jaula lanzamiento fabricada en nylon de 43 x 43 x 4,5 mm.

Simple nylon net for hammer and discus cage. Dimensions 43 x 43 x 4,5 mm.

*Imagen/Picture C*



A

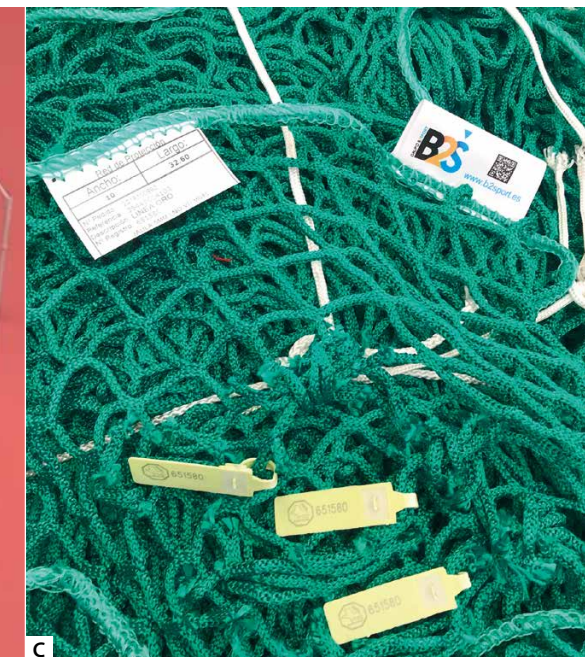

C



B



33046

Círculo metálico lanzamiento de discos tangencial Ø 2500 mm.  
Metallic tangential discus throw ring Ø 2500 mm.

*Imagen/Picture D*

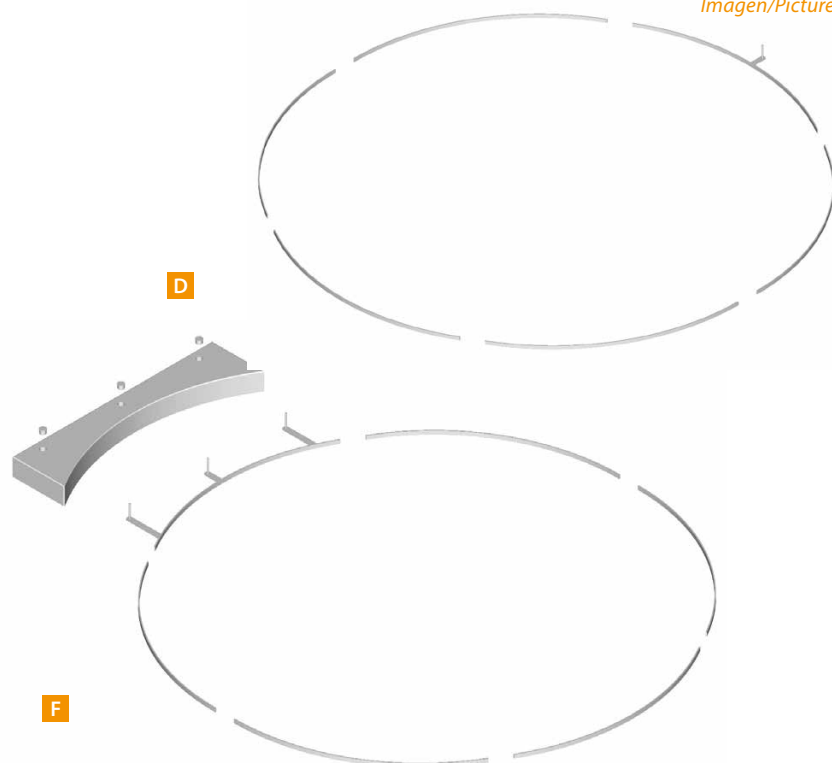

33052

Contenedor de círculo para lanzamiento de peso fabricado en fibra de vidrio.  
Shot put ring container made of fiberglass.

*Imagen/Picture F*

33046A

Círculo metálico lanzamiento martillo tangencial Ø 2135 mm.  
Metallic tangential hammer and shot ring Ø 2135 mm.

*Imagen/Picture E*

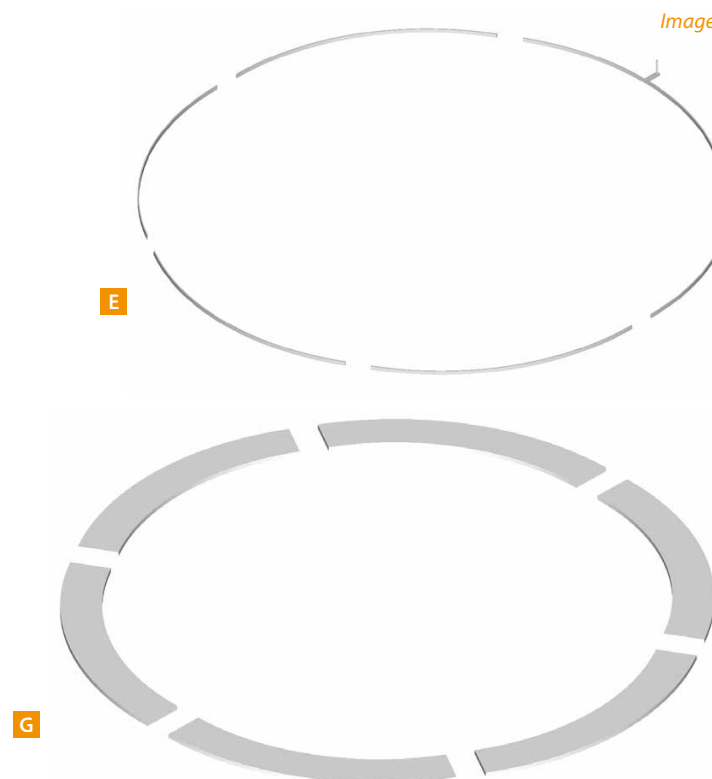

33046C

Pieza reducción del círculo de disco a martillo.  
Hammer conversion circle.

*Imagen/Picture G*



**B**

LANZAMIENTOS THROWING

**33055**

Juego indicadores distancia, fabricados en fibra de vidrio. Muestra cada metro de 10 a 23 m. y cada diez metros de 30 a 90 m.

Set of distance markers made of fibreglass. Shows every metre from 10 to 23 m. or every ten metre from 30 to 90 with large digits.

*Imagen/Picture A*



**33018**

Juego de banderas de pista libre.

Set of free track flags.

*Imagen/Picture B*



**33558**

Indicador dirección del viento.

Wind gauge indicator.

*Imagen/Picture C*

**33054**

Juego de banderas de límite de sector.

Set of sector boundary flags.

*Imagen/Picture D*



33059

Enrollador de cinta metálica con manivela.  
Throwing sector delimiting ribbon winding trolley.

*Imagen/Picture E*



E

33058

Rollo cinta delimitación de sector.  
Throwing sector delimiting.

*Imagen/Picture F*



F

11067

Magnesiero.  
Powder coated steel magnesium holder.

*Imagen/Picture G*



G



B

LANZAMIENTOS / PESOS THROWING / SHOTS  
DIFERENTES PESOS, CONSULTAR WEB DIFFERENT WEIGHTS, CHECK OUR WEBSITE



33202

Pesos hierro fundido certificados IAAF, diferentes pesos y dimensiones.

Shot cast iron of different weights and dimensions. IAAF certified.

*Imagen/Picture A*



A

33269

Canal para retorno de pesos.

Shot return channel.

*Imagen/Picture B*



B

33231

Pesos bronce certificados IAAF, diferentes pesos y dimensiones.

Shot brass of different weights and dimensions. IAAF certified.

*Imagen/Picture C*



C

33200

Carro porta pesos.

Shot stand with wheels.

*Imagen/Picture D*

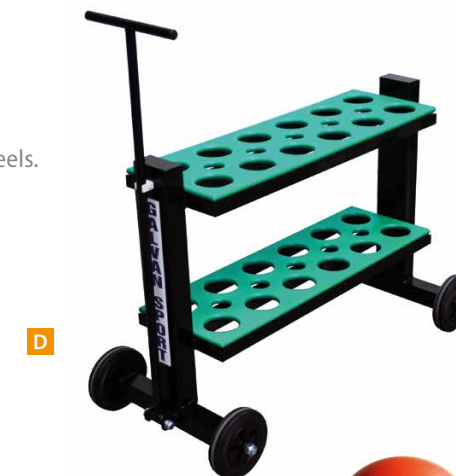

D

33236

Pesos acero inoxidable certificados IAAF, diferentes pesos y dimensiones.

Shot stainless steel of different weights and dimensions. IAAF certified.

*Imagen/Picture E*



E

33549

Pesos caucho diferentes pesos y dimensiones.

Shot rubber of different weights and dimensions.

*Imagen/Picture F*



F



33061

Discos fibra de vidrio certificados IAAF de diferentes pesos.  
Fibreglass discus of different weights IAAF certified.

*Imagen/Picture G*



G



I

Discos caucho de diferentes pesos.  
Rubber discus of different weights.

*Imagen/Picture I*

33072



J

Discos súper élite en fibra de vidrio y borde en  
acero inoxidable certificado IAAF.  
Fiberglass discus of different weights with the  
rim made of stainless steel. IAAF certified.

*Imagen/Picture J*

33066

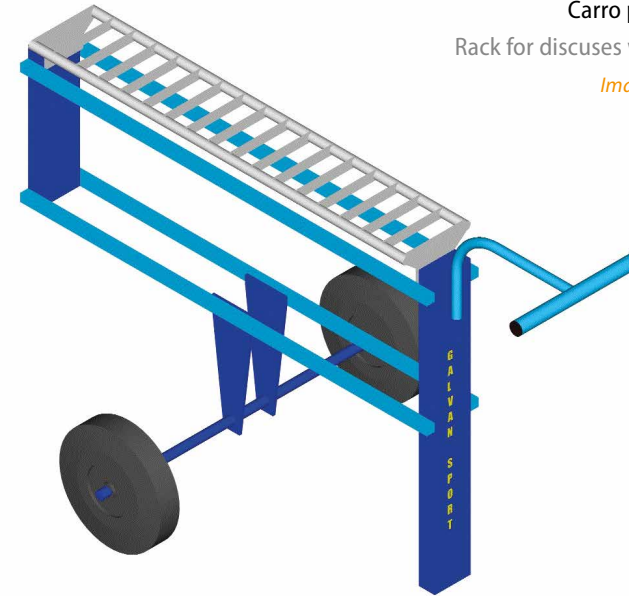

Carro porta discos.  
Rack for discuses with wheels.

*Imagen/Picture H*

33090

**B**

LANZAMIENTOS / PESOS THROWING / SHOTS

**33285**

Guante lanzamiento de martillo. En cuero natural. Tallas S - M - L - XL.

Gloves for hammer trowing. Natural leather. S - M - L - XL sizes.

*Imagen/Picture A*

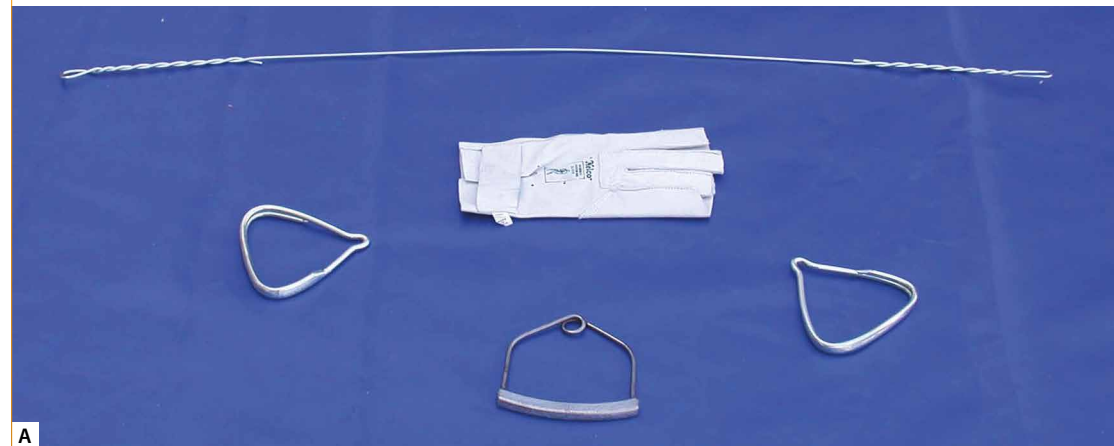
**A****33286**

Cable de acero, repuesto para martillos. Diferentes longitudes.

Steel spare wires for hammers. Available in different lengths.

*Imagen/Picture A*

**416001**

Vortex Maxi es la mezcla perfecta entre la práctica y el juego.  
Uso para calentamiento o práctica.

Vortex Maxi is the perfect mix between practise and play. You can warm up with it for a field-event or play around with it on practise.

*Imagen/Picture B*

**33282**

Asa de repuesto para martillos.

Hammer handle.

*Imagen/Picture A*

**B**





33300

Martillos acero inoxidable certificados IAAF diferentes pesos y dimensiones.  
Hammer stainless steel of different weights and dimensions. IAAF certified.

*Imagen/Picture C*



33305

Martillos bronce certificados IAAF diferentes pesos y dimensiones.  
Hammer brass of different weights and dimensions. IAAF certified.

*Imagen/Picture D*



33541

Martillos hierro certificados IAAF diferentes pesos y dimensiones.  
Hammer cast iron of different weights and dimensions. IAAF certified.

*Imagen/Picture E*



33268

Martillos caucho diferentes pesos y dimensiones.  
Indoor hammer made of rubber. Available in different weights and dimensions.

*Imagen/Picture F*



F

33281

Carro portamartillos.  
Hammer stand.

*Imagen/Picture G*

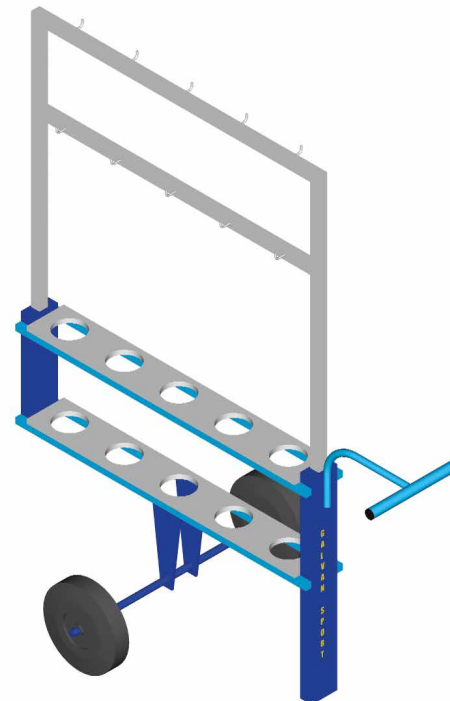

G



**B**

LANZAMIENTOS / Jabalinas **THROWING** / Javelins  
CONSULTAR WEB PARA MÁS INFORMACIÓN **CHECK OUR WEBSITE FOR MORE INFORMATION**

**33185A**

Pelota para entrenamiento de lanzamiento de jabalina.  
Consultar diferentes pesos.

Javeline throwing balls. Available in different weights.

*Imagen/Picture A*



**33054A**

Juego de banderas metálicas de delimitación límite de sector con números.  
De 10 a 22 y de 30 a 90.

Metallic distance marker with numbers. From 10 to 22 and from 30 to 90.

*Imagen/Picture B*



**33140**

Carro porta jabalinas.

Javeline stand.

*Imagen/Picture C*





Jabalinas Valkyrie Nordic fabricadas en aluminio ó carbono de alta calidad.  
Disponible en 600 gr. y 800 gr. Certificada IAAF.

Javelin Valkyrie Nordic made of aluminum or high quality carbon.  
Available in 600 gr. and 800 gr. IAAF certified.

*Imagen/Picture D*



D



F

Jabalina escolar Nordic fabricada en aluminio y plástico para evitar riesgo de lesiones. Dimensiones: 115 cm. y peso 270 gr. Recomendado para edades comprendidas entre 4 - 10 años.

Nordic Fly-Hi Javelin made of aluminium with tip and tail of plastic which are blunt in order to eliminate risk of injury. Cotton cord. Weight 270 g. Length 115 cm. Suited for children between 4 - 10 years.

*Imagen/Picture F*

Jabalinas de competición Valhalla Nordic fabricadas en aluminio o carbono de alta calidad. Disponible en diferentes pesos. Certificada IAAF.

Competition javelin Valhalla Nordic made of aluminum or high quality carbon. Available in different weights. IAAF certified.

*Imagen/Picture E*

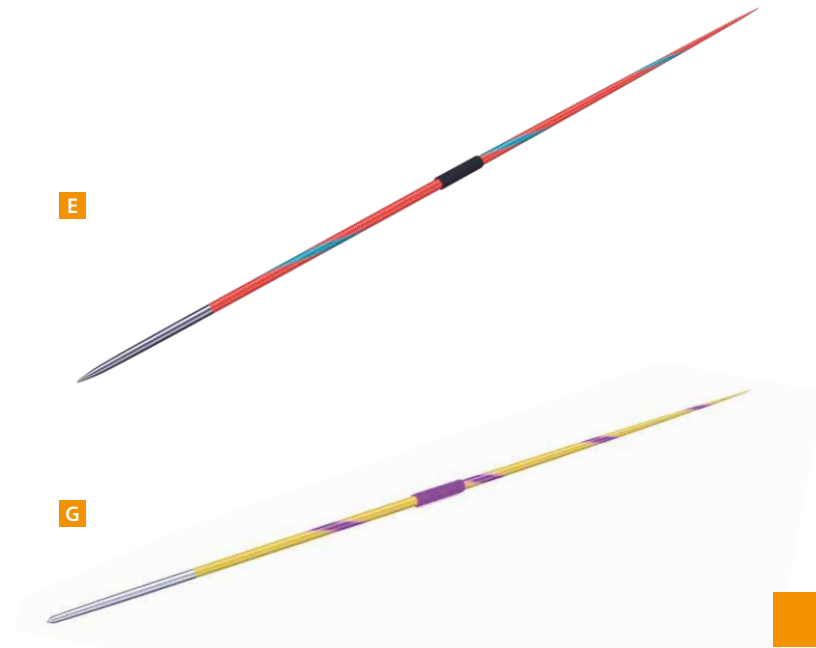

E



G

Jabalina clásica Nordic fabricadas en acero de alta calidad.  
Disponibile en diferentes pesos. Certificada IAAF.

Javelin Valkyrie Nordic made of high quality steel. Available in different weights. IAAF certified.

*Imagen/Picture G*



C

SALTOS / SALTO CON PÉRTIGA JUMP / POLE VAULT



33402

Saltómetro pértiga competición certificado IAAF.

Set of pole vault uprights IAAF certified.

*Imagen/Picture A*

A



33263

Listón salto con pértiga en fibra de vidrio de 4,50 m. Con topes de goma. Certificado IAAF.

4,50 m. Pole vault crossbar made in fibre-glass. With rubber ends. IAAF certified.

*Imagen/Picture B*

B



33403A

Elevador listón salto pértiga.

Crossbar elevator for pole vault.

*Imagen/Picture C*



33403

Medidor telescópico manual de salto de pértiga.

Telescopic manual pole jump meter.

*Imagen/Picture D*



C D



33420

Carro transporte pértigas, cuatro ruedas neumáticas.  
Pole rack mobile with 4 pneumatic wheels.

*Imagen/Picture E*

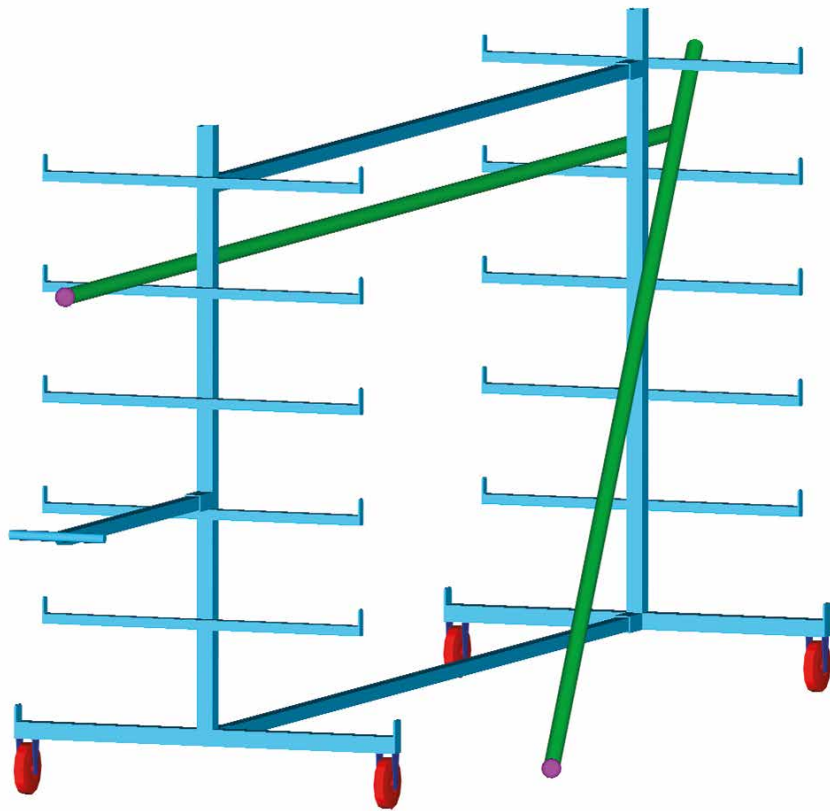

E

33400

Tapa metálica para cajetín de salto pértiga.  
Lid for pole vault box.

*Imagen/Picture F*

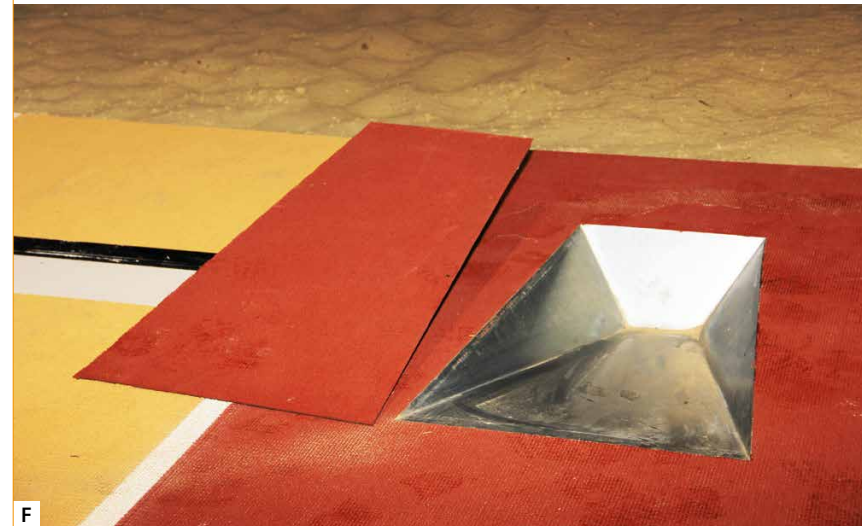

F

33401

Cajetín de salto pértiga.  
Pole planning box.

*Imagen/Picture F*



C

SALTOS / PÉRTIGAS JUMP / POLES  
CONSULTAR WEB PARA MÁS INFORMACIÓN CHECK OUR WEBSITE FOR MORE INFORMATION



Pértiga Nordic fabricada en fibra de vidrio de acuerdo a los estándares internacionales. Disponible en medidas desde 3,35 m. hasta 5,20 m. Certificada IAAF.

Nordic pole made of fiberglass according international standards. Available in dimensions from 3,35 m. to 5,20 m. IAAF certified.

Imagen/Picture A



A

Pértiga Nordic modelo Evo2 fabricada en diferentes materiales que ayudan a conseguir resultados mejorados a los atletas. Son más ligeras que las de fibra de vidrio y con menor diámetro. Medidas desde 4 m. hasta 5,20 m. Certificada IAAF.

Nordic pole made of different material which help athletes to get better results. This type of pole is lighter than fiberglass pole and they are smaller in diameter. Available in dimensions from 4 to 5,20 m. IAAF certified.

Imagen/Picture B



B



C

33415

Somier para colchonetas de salto con pértiga 8,00 x 6,00 m.  
Paling grid for pole vault landing mats 8,00 x 6,00 m.

Imagen/Picture C

33414

Somier para colchonetas de salto con pértiga 7,00 x 6,00 m.  
Paling grid for pole vault landing mats 7,00 x 6,00 m.

Imagen/Picture C

33412

Somier para colchonetas de salto con pértiga 7,00 x 5,00 m.  
Paling grid for pole vault landing mats 7,00 x 5,00 m.

Imagen/Picture C



33267

Colchoneta zona de caídas 8,00 x 6,00 x 0,81 m. salto de pértiga, incluye las protecciones para los soportes. Certificado IAAF.

Pole vault landing areas with dimensions 8,00 x 6,00 x 0,81 m., Protection pads for stands included. Certified by IAAF.

*Imagen/Picture D*



D

33264

Colchoneta zona de caídas 7,00 x 5,00 x 0,81 m. salto de pértiga. Fabricada con espuma extra suave para evitar lesiones.

Pole vault landing areas with dimensions 7,00 x 5,00 x 0,81 m. Made of extra soft foam in order to avoid injuries.

*Imagen/Picture D*

33265

Colchoneta zona de caídas 8,00 x 6,00 x 0,81 m. salto de pértiga. Fabricada con espuma extra suave para evitar lesiones.

Pole vault landing areas with dimensions 8,00 x 6,00 x 0,81 m. Made of extra soft foam in order to avoid injuries.

*Imagen/Picture D*

33266

Colchoneta zona de caídas 7,00 x 6,00 x 0,81 m. salto de pértiga. Fabricada con espuma extra suave para evitar lesiones.

Pole vault landing areas with dimensions 7,00 x 6,00 x 0,81 m. Made of extra soft foam in order to avoid injuries.

*Imagen/Picture D*



C

SALTOS / PÉRTIGAS JUMP / POLES

33405

Lona protectora de colchoneta para salto con pértiga 7,00 x 5,00 m.

Protective cover for pole vault landing area 7,00 x 5,00 m.

*Imagen/Picture A*

33407

Lona protectora de colchoneta para salto con pértiga 7,00 x 6,00 m.

Protective cover for pole vault landing area 7,00 x 6,00 m.

*Imagen/Picture A*

33408

Lona protectora de colchoneta para salto con pértiga 8,00 x 6,00 m.

Protective cover for pole vault landing area 8,00 x 6,00 m.

*Imagen/Picture A*



33416

Garaje cubre colchonetas metálico 7,50 x 5,50 m.

Garage for P.V. landing pit 7,50 x 5,50 m.

*Imagen/Picture B*

33418

Garaje cubre colchonetas metálico 7,50 x 6,50 m.

Garage for P.V. landing pit 7,50 x 6,50 m.

*Imagen/Picture B*

33419

Garaje cubre colchonetas metálico 8,50 x 6,50 m.

Garage for P.V. landing pit 8,50 x 6,50 m.

*Imagen/Picture B*





33241

Listón salto de altura competición en fibra de vidrio de 4 m. con topes de goma. Certificado IAAF.  
High jump competition cross-bar made in fibreglass 4 m. with rubber ends. IAAF certified.

*Imagen/Picture C*



C

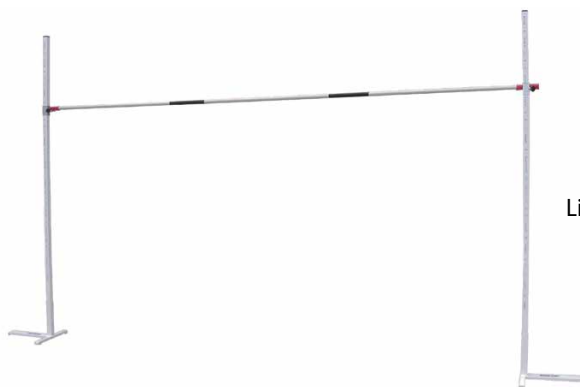

D

33363

Listón salto de altura en aluminio de 4 m. para entrenamiento.  
Aluminium high jump cross - bar for training 4 m.

*Imagen/Picture D*

33352A

Saltómetro salto de altura competición fabricado acorde normas IAAF.  
Competition high jump manufactured according IAAF standards.

*Imagen/Picture E*



E

F

33352B

Saltómetro para salto de altura de competición.  
Fabricado en aluminio con regulación de 60 a 260 cm. Certificado IAAF.  
Competition high jump standard made of aluminium.  
Adjustable from 60 to 260 cm. IAAF certified.

*Imagen/Picture F*

**D**

SALTOS / SALTO DE ALTURA JUMP / HIGH JUMP

**33241A**

Listón salto de altura en gomaespuma, para iniciación.  
Antilesión y fácilmente apilable.

Beginners high jump cross-bar made of foam.

*Imagen/Picture A*

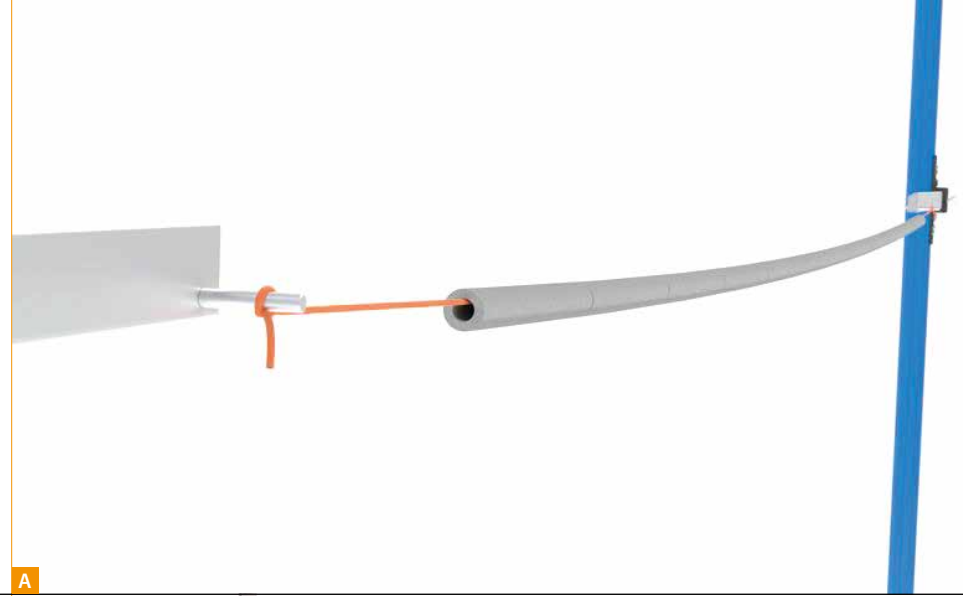
**33353**

Saltómetro salto de altura escolar.  
Aluminium high jump standars.

*Imagen/Picture B*

**33353B**

Medidor salto de altura extensible y telescópico hasta 2,50 m.

Telescopic and extensible high jump measurer up to 2,50 m. for easy and quickly checking.

*Imagen/Picture C*



33226

Colchoneta salto de altura medidas 6,00 x 4,00 x 0,70 m.  
Fabricada con espuma extra suave para evitar lesiones. Certificada IAAF.  
High jump landing area with dimensions: 6,00 x 4,00 x 0,70 m.  
Made of extra soft foam anti injured. IAAF certified.

*Imagen/Picture D*



D

33225

Colchoneta salto altura de medidas 5,00 x 3,00 x 0,70 m.  
Fabricada con espuma extra suave para evitar lesiones.  
High jump landing area with dimensions: 5,00 x 3,00 x 0,70 m.  
Made of extra soft foam anti injured.

*Imagen/Picture E*



E

33227

Colchoneta salto altura de medidas 5,00 x 4,00 x 0,70 m.  
Fabricada con espuma extra suave para evitar lesiones.  
High jump landing area with dimensions: 5,00 x 4,00 x 0,70 m.  
Made of extra soft foam anti injured.

*Imagen/Picture E*

33228

Colchoneta salto altura de medidas 6,00 x 4,00 x 0,70 m.  
Fabricada con espuma extra suave para evitar lesiones.  
High jump landing area with dimensions: 6,00 x 4,00 x 0,70 m.  
Made of extra soft foam anti injured.

*Imagen/Picture E*

**D**

SALTOS / SALTO DE ALTURA JUMP / HIGH JUMP

**33361**

Somier colchoneta salto altura 5,00 x 3,00 m.  
Palling grid for high jump landing area 5,00 x 3,00 m.

*Imagen/Picture A*

**A****33362**

Somier colchoneta salto altura 5,00 x 4,00 m.  
Palling grid for high jump landing area 5,00 x 4,00 m.

*Imagen/Picture A*

**33369**

Somier colchoneta salto altura 6,00 x 4,00 m.  
Palling grid for high jump landing area 6,00 x 4,00 m.

*Imagen/Picture A*

**B**



33356

Lona protectora cubre colchonetas 5,00 x 4,00 x 0,70 m.  
Protective cover for high jump landing area 5,00 x 4,00 x 0,70 m.

*Imagen/Picture B*

33354

Lona protectora cubre colchonetas 5,00 x 3,00 x 0,70 m.  
Protective cover for high jump landing area 5,00 x 3,00 x 0,70 m.

*Imagen/Picture B*

33357

Lona protectora cubre colchonetas 6,00 x 4,00 x 0,70 m.  
Protective cover for high jump landing area 6,00 x 4,00 x 0,70 m.

*Imagen/Picture B*

33365

Garaje cubre colchonetas metálico 5,50 x 3,50 m.  
Garage for H.J landing pit 5,50 x 3,50 m.

*Imagen/Picture B-C*

33367

Garaje cubre colchonetas metálico 5,50 x 4,50 m.  
Garage for H.J landing pit 5,50 x 4,50 m.

*Imagen/Picture B-C*

33368

Garaje cubre colchonetas metálico 6,50 x 4,50 m.  
Garage for H.J landing pit 6,50 x 4,50 m.

*Imagen/Picture B-C*



**E**

SALTOS / SALTO DE LONGITUD Y TRIPLE SALTO JUMP / LONG JUMP AND TRIPLE JUMP

**33380**

Soposte metálico tabla de batida. Fabricado con chapa de acero de calidad, laminada en frío y posteriormente galvanizada en caliente.  
Galvanized steel support for take - off board.

*Imagen/Picture A*

**33381**

Tabla batida para alojar plastilina. Pintada en color blanco.  
Uso interior y exterior.  
Plasticine board. Solid pinewood board painted in white,  
to place the plasticine.

*Imagen/Picture A*

**33382**

Tapa metálica para tabla de batida, recubierta de tartán.  
Galvanizado en caliente.  
Take off metallic lid cover with rubber. Hot - dip galvanized.

*Imagen/Picture B*

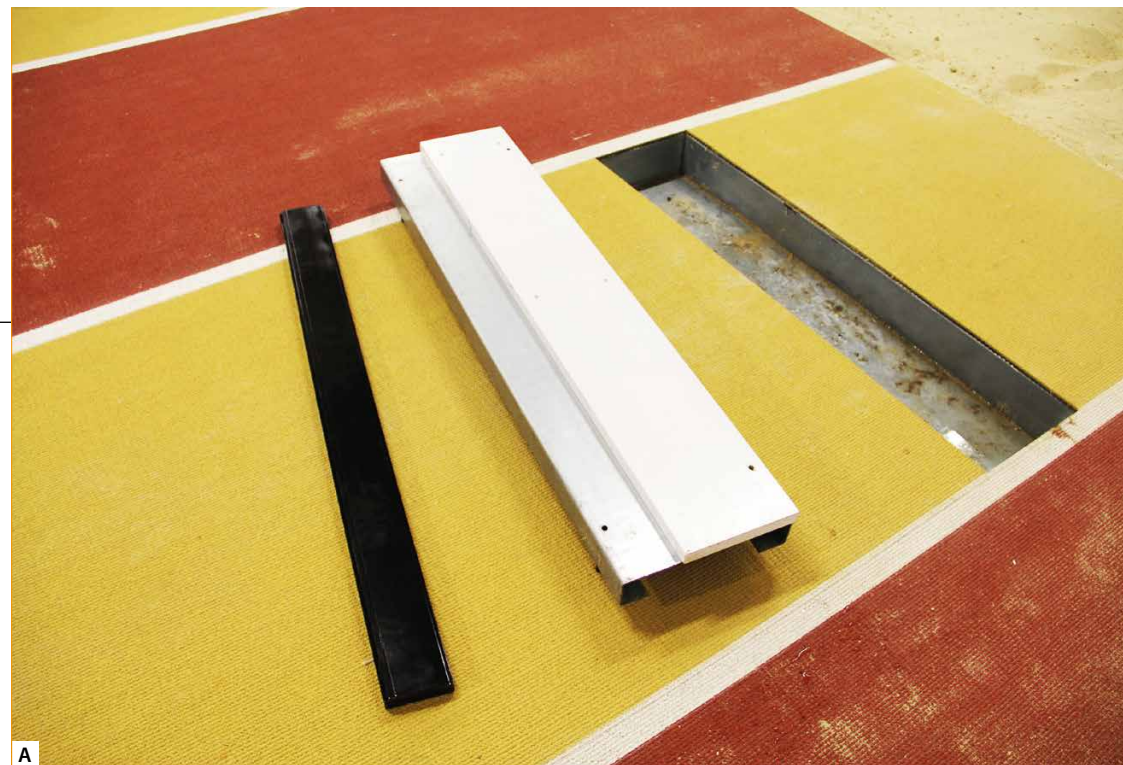
**A****B**



33387

Espátula para alisar la plastilina.  
Spatula for smoothing the plasticine.

*Imagen/Picture C*



C

33383

Tabla de escala métrica con doble escala:  
por un lado para salto de longitud y por el otro, escala para triple salto.  
Distance indicator for long and triple jump.

*Imagen/Picture D*

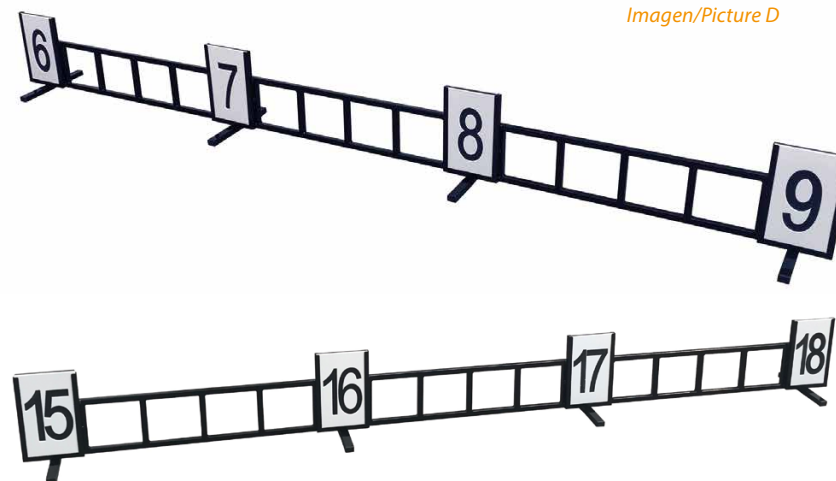

D

33384

Referencias para tabla de batida.  
Take off board - markers.

*Imagen/Picture E*

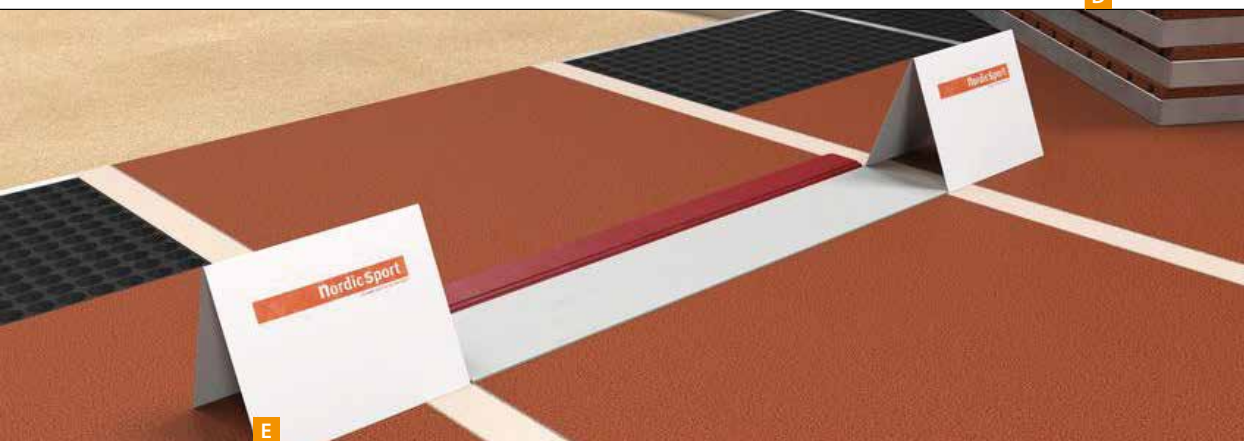

E

**E**

SALTOS / SALTO DE LONGITUD Y TRIPLE SALTO JUMP / LONG JUMP AND TRIPLE JUMP

**33386A**

Carro transporte equipos de plastilina para saltos, con ruedas.

Rack for equipment plasticine with wheels.

*Imagen/Picture A*

**A****33389**

Juego 12 marcas de señalización prueba de saltos. Varios colores.

Take off steel markers set of 12. Available in different colours.

*Imagen/Picture B*

**B****43003B**

M<sup>2</sup> de lona protectora ignífuga y lavable para fosos de arena en las pistas de atletismo. Fabricada en lona de trevira plastificada por las dos caras y un peso de 620 gr/m<sup>2</sup>.

M<sup>2</sup> of protective canvas for long jump and triple jump, sand pits. Made of fabric canvas plasticized on both sides and weighing 620 gr/m<sup>2</sup>.

*Imagen/Picture C*

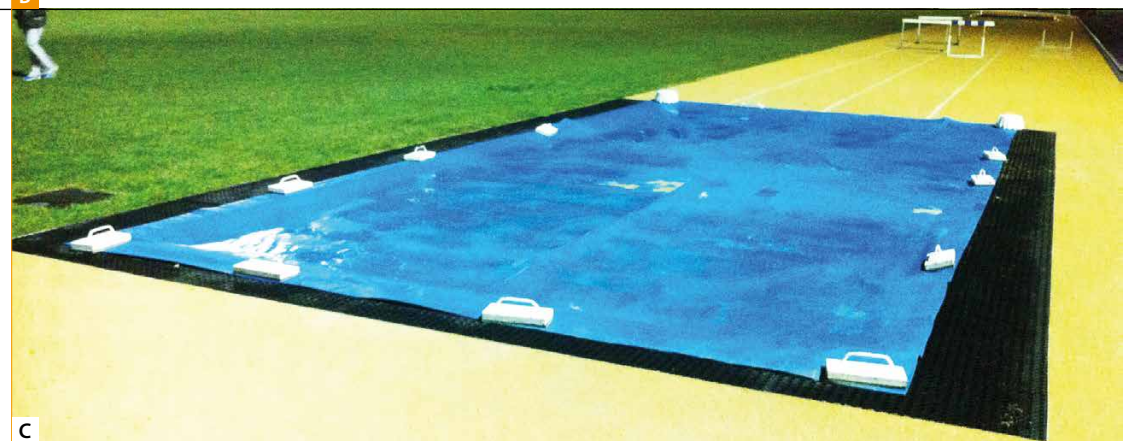
**C**





34089A

Marcador 4 dígitos de sobremesa.  
4 digits desktop manual scoreboard.

*Imagen/Picture D*



D

34093

Marcador persiana de 8 dígitos.  
8 digits manual scoreboard.

*Imagen/Picture E*



E

33332

Recambio dígito de persiana en color negro.  
Spare blind digit numbers 0-9 for scoreboard. Black colour.

*Imagen/Picture D*

33331

Recambio dígito de persiana en color rojo.  
Spare blind digit numbers 0-9 for scoreboard. Red colour.

*Imagen/Picture D*

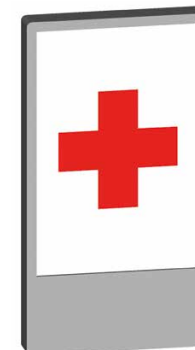

33332B

Repuesto dígito de persiana " + - ".  
Spare blind digit " + - " for scoreboards.

*Imagen/Picture F*

F



F

33557

Indicador anemómetro manual de 4 dígitos.  
4 digits manual wind gauge indicator.

*Imagen/Picture A*

A



33586

Topómetro contador mecánico.  
Measuring wheel.

*Imagen/Picture B*

B



C



C



33581

Cintas métricas fibra de vidrio de 10 m. a 100 m.  
Fibreglass measuring tape from 10 m. to 100 m.

*Imagen/Picture C*

33585

Cintas métricas metálicas de 10 m. a 100 m.  
Metallic measuring tape from 10 m. to 100 m.

*Imagen/Picture C*

C





D

Cajones pliométricos. Set de 3 unidades.

Plyo box. Set 3 units.

*Imagen/Picture D*

550568



E

Banderas para jueces blanca, roja y amarilla.

Judge flags. Red, white and yellow.

*Imagen/Picture E*

33015



F

Megáfono.

Megaphone.

*Imagen/Picture F*

33575



G

Podium ganadores de forma cúbica de tres alturas metálico.

Cube shaped champions pódium with three heights metallic.

*Imagen/Picture G*

33001

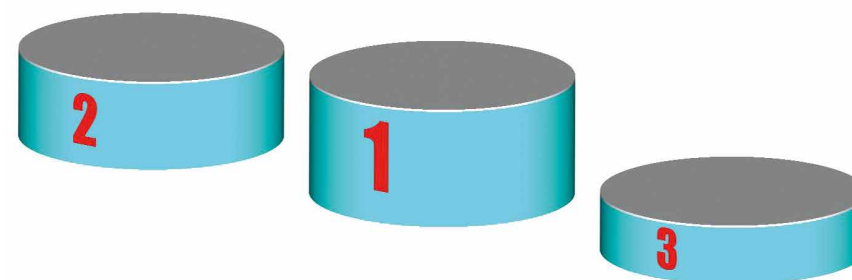

H

Podium ganadores de forma circular.

Podium for winners cubic shaped.

*Imagen/Picture H*

33002



# EQUIPAMIENTO DE ATLETISMO

## ATHLETICS EQUIPMENT



P. I. Oporto 1, 2. 47520 Castronuño (Valladolid) SPAIN

Tel.: [34] 983 866 333

Mail: [clientes@galvansport.com](mailto:clientes@galvansport.com)

[www.galvansport.com](http://www.galvansport.com)

